

Materials Needed

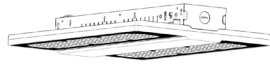

Linear Highbay
Fixture



V hook



Screw
Driver

Aircraft Cable Mounting

- Put the hanging rope through fixation place and hole of the locker.

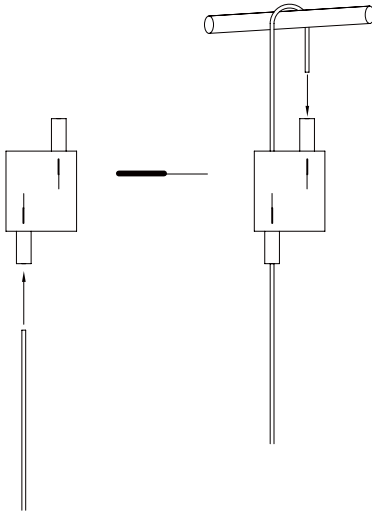

- Connect hanging rope to V hook and match V hook to the holes available on the driver box.

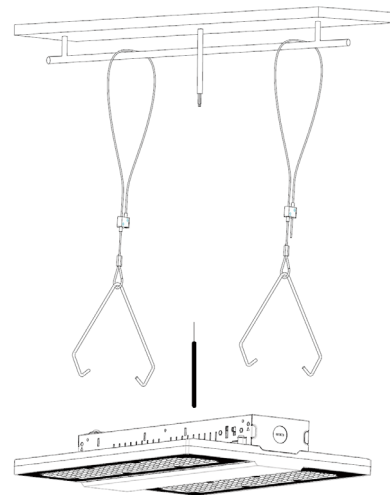

- Complete the wiring per below details, access plate of AC cable can be opened if needed.

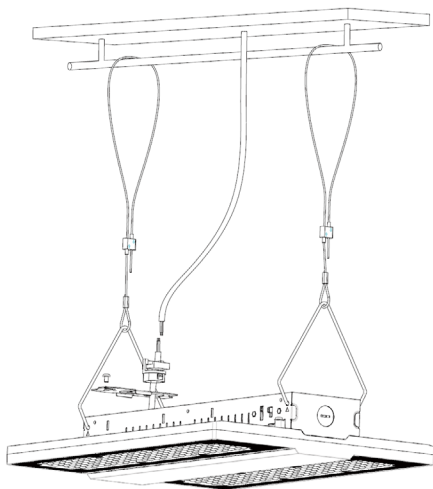

Brown/Black	○	Line
Blue/White	○	Neutral
Yellow/Green	○	Ground

- Adjust the length of the hanging cable by press the locker to a appropriate installation height.

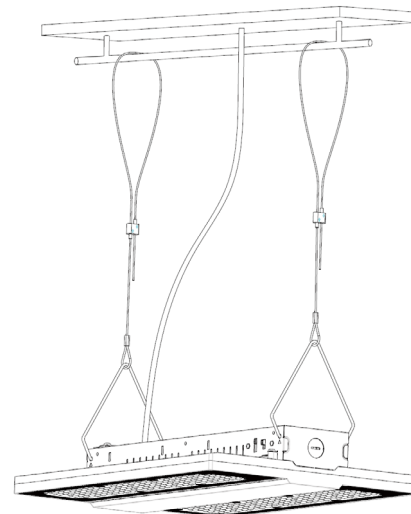

Materials Needed

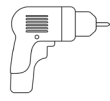

Drill



4pcs expansion screws

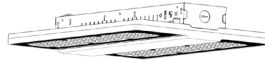

Linear Highbay Fixture



Screw Driver

Surface Mounting

1. Drill 4 holes (diameter 6mm) on the ceiling with 40mm depth for the expansion screws per below dimension.

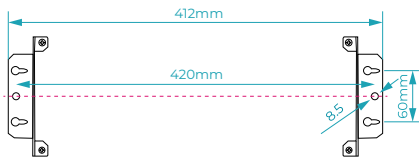
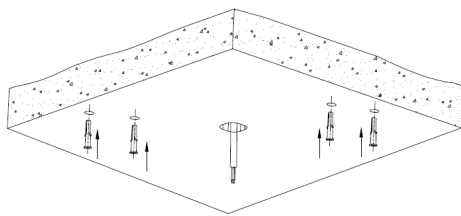

2. Fix the surface mount plate onto the light and fix the light onto the ceiling with 4pcs expansion screws.

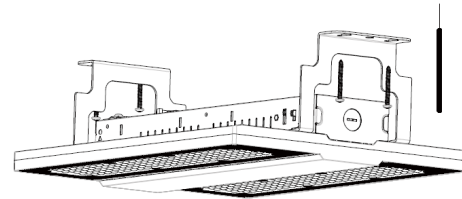
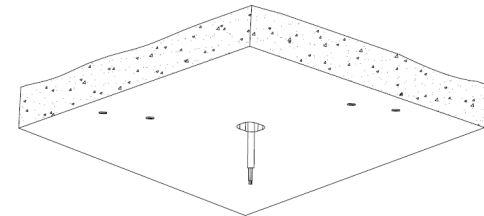

3. Complete the wiring per below details.

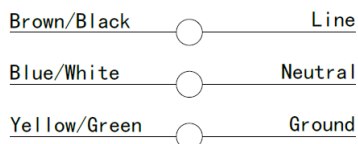
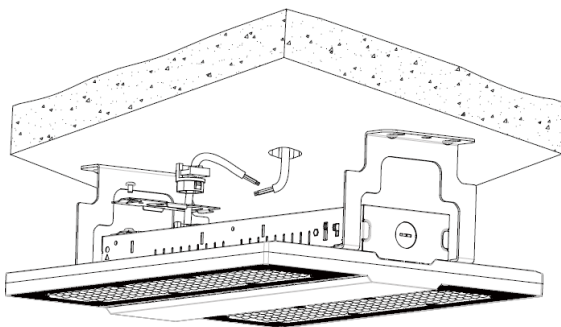

4. Access plate of AC cable can be removed for wiring, put back the access plate after wiring process.

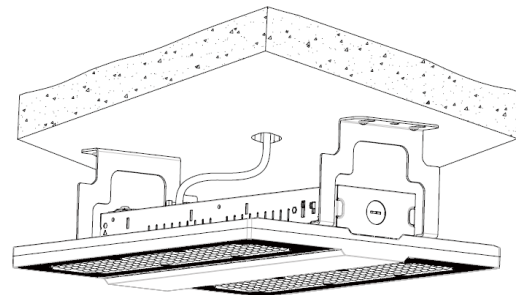

- WARNING -** DISCONNECT OR TURN OFF POWER BEFORE INSTALLATION OR SERVICING.
- WARNING -** VERIFY THAT SUPPLY VOLTAGE IS CORRECT BY COMPARING IT WITH THE LUMINAIRE LABEL.
- WARNING -** THE LUMINAIRE SHALL BE INSTALLED BY A QUALIFIED ELECTRICIAN AND WIRED IN ACCORDANCE WITH THE LATEST IEE OR NEMA ELECTRICAL REGULATIONS OR THE NATIONAL REQUIREMENTS.
- WARNING -** MAKE ALL ELECTRICAL AND GROUNDED CONNECTIONS IN ACCORDANCE WITH ANY APPLICABLE LOCAL CODE REQUIREMENTS.
- WARNING -** ALL WIRING CONNECTIONS SHOULD BE CAPPED WITH APPROVED RECOGNIZED WIRE CONNECTORS.
- WARNING -** ALLOW LAMP/FIXTURE TO COOL BEFORE HANDLING. DO NOT TOUCH ENCLOSURE OR LIGHT SOURCE.
- WARNING -** FOLLOW ALL MANUFACTURER'S WARNINGS, RECOMMENDATIONS AND RESTRICTIONS FOR: DRIVER TYPE, BURNING POSITION, MOUNTING LOCATIONS/METHODS, REPLACEMENT AND RECYCLING.
- WARNING -** IF THE EXTERNAL FLEXIBLE CABLE OR CORD OF THIS LUMINAIRE IS DAMAGED, IT SHALL BE EXCLUSIVELY REPLACED BY THE MANUFACTURER OR HIS SERVICE AGENT OR A SIMILAR QUALIFIED PERSON IN ORDER TO AVOID A HAZARD.
- WARNING -** THE LIGHT SOURCE OF THIS LUMINAIRE IS NOT REPLACEABLE; WHEN THE LIGHT SOURCE REACHES ITS END OF LIFE THE WHOLE LUMINAIRE SHALL BE REPLACED.
- WARNING -** YOU MUST CONNECT THE INPUT POWER CABLE TO THE POWER SUPPLY USING THE SAME IP LEVEL AND A JUNCTION BOX WITH A CORD ANCHORAGE DEVICE.