

INSTALLATION INSTRUCTION

BALLAST BYPASS OR BALLAST COMPATIBLE

The VALTO Hybrid LED Solution offers unparalleled flexibility - it is the first in the industry to be UL Listed for use with all ANSI magnetic ballasts (175-600W) as well as ballast bypass to mains line voltage (120-277V).

***WARNING: Do not use controls with Ballast operation.**

BALLAST BYPASS

Bypassing the ballast enables the best energy saving by rerouting the mains power around the ballast to power the lamp directly. In this configuration the ballast no longer consumes power, saving typically an additional 50W. This creates the optimum power factor of >0.95 See reverse side for ballast bypass installation instructions.

BALLAST COMPATIBLE

This option is the simplest way to replace existing HID lamps, without the need for electricians: just change the lamp. In event of future ballast failure, you can still use the existing asset and bypass the failed ballast to power the lamp directly from the mains line voltage.

Direct Replacement for HID target lamps only including:

- Metal Halide: M59/M155, M131, M154, M153/M58, M136, M57/M152
- Mercury Vapor: H33, H37
- High Pressure Sodium: S106, S50, S66

Ballast Compatible OR Ballast Bypass

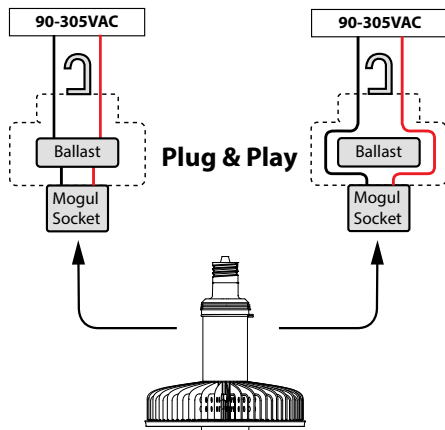

FIXTURE COMPATIBILITY

Reflector Optional

Valto Lamp contains its own optics and does not require an external reflector. However, to preserve the traditional look the reflector may be left in place.

Enclosed Fixtures

The Valto 105W version is compatible with fully enclosed fixtures. Minimum lamp compartment dimensions: Luminaire with Dome Shade with overall, min. 56 cm (22") diam. opening at the bottom, tapering to 16.5 cm (6.5") diam. on top, min. 38.1 (15") cm depth, or rectangular lamp compartment with overall, min. 56 cm (22") square, with max. 38.1 (15") cm depth."

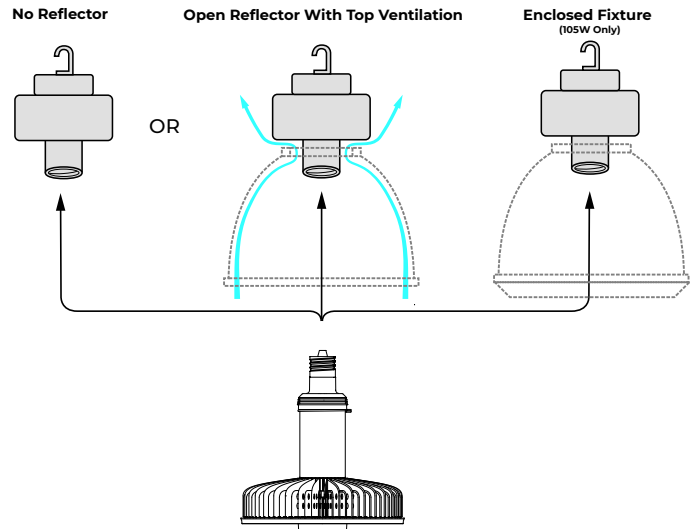





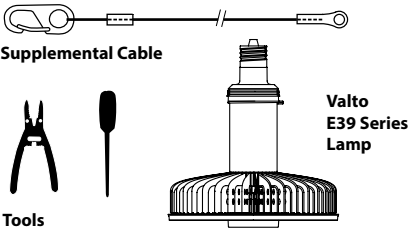

CERTIFICATIONS

- Suitable for Dry and Damp locations.
- 105W suitable for enclosed fixtures
- 105W / 150W Suitable for open vented fixtures

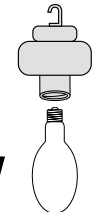

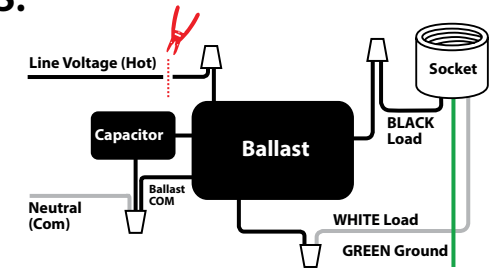
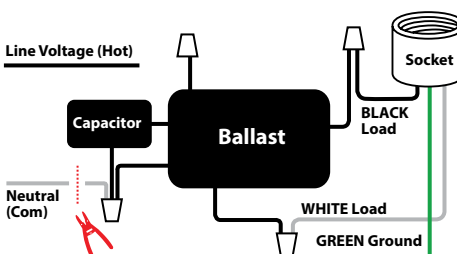
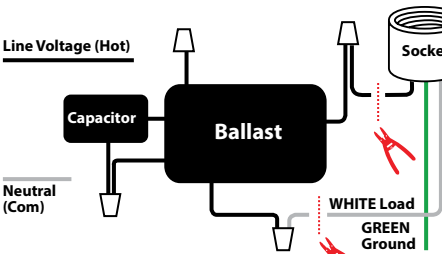
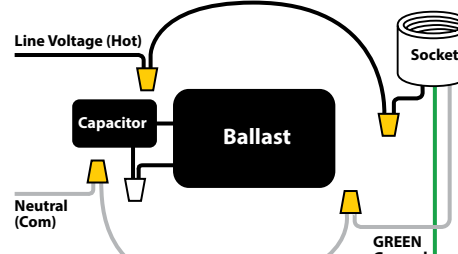
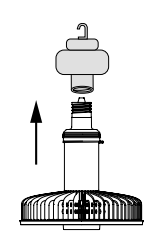
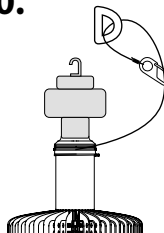
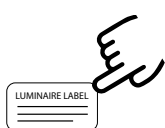
INSTALLATION INSTRUCTION

<p>1.</p>  <p>Supplemental Cable</p> <p>Tools</p> <p>Valto E39 Series Lamp</p> <p>Make sure you have the required parts and tools.</p>	<p>2.</p>  <p>Turn power to fixture off.</p>	<p>3.</p>  <p>Remove HID lamp.</p>	<p>4.</p>  <p>Make sure socket is not damaged.</p>	<p>5.</p>  <p>Disconnect Line Voltage (Hot Wire) from ballast.</p>
<p>6.</p>  <p>Disconnect neutral from ballast.</p>	<p>7.</p>  <p>Disconnect the socket from the ballast completely.</p>	<p>8.</p>  <p>Connect Hot (120VAC-277VAC) to black wire and Neutral to white wire connected to socket.</p>		
<p>9.</p>  <p>Install Valto Hybrid LED Lamp.</p>	<p>10.</p>  <p>Attach safety harness.</p>	<p>11.</p>  <p>Apply re-lamping label on a visible location outside the fixture.</p>	<p>12.</p>  <p>Turn power on.</p>	

WARNING - RISK OF FIRE OR ELECTRIC SHOCK. LED RETROFIT KIT INSTALLATION REQUIRES KNOWLEDGE OF LUMINAIRE'S ELECTRICAL SYSTEM. IF NOT QUALIFIED, DO NOT ATTEMPT INSTALLATION. CONTACT A QUALIFIED ELECTRICIAN.

WARNING - RISK OF FIRE OR ELECTRIC SHOCK. INSTALL THIS KIT ONLY IN LUMINAIRES THAT HAVE THE CONSTRUCTION FEATURES AND DIMENSIONS SHOWN IN PRODUCT SPECIFICATION SHEET AND/OR DRAWINGS AND WHERE THE INPUT RATING OF THE RETROFIT KIT DOES NOT EXCEED THE INPUT RATING OF THE LUMINAIRE.

WARNING - DO NOT MAKE OR ALTER ANY OPEN HOLES IN AN ENCLOSURE OF WIRING OR ELECTRICAL COMPONENTS DURING KIT INSTALLATION.

WARNING - THIS LAMP IS NOT INTENDED FOR USE WITH EXTERNAL LED DRIVER. LAMP INSTALLATION WITH EXTERNAL DRIVER VOIDS THE PRODUCT WARRANTY.

WARNING - TO PREVENT WIRING DAMAGE OR ABRASION, DO NOT EXPOSE WIRING TO EDGES OF SHEET METAL OR OTHER SHARP OBJECTS.

CAUTION - DO NOT INSTALL THIS LAMP TO LINE VOLTAGE ABOVE 277VAC. THIS LAMP SUPPORTS 120VAC - 277VAC VOLTAGE RANGE.

CAUTION - IF THE LAMP OR LUMINAIRE EXHIBITS UNDESIRABLE OPERATION (BUZZING, FLICKERING, ETC.), IMMEDIATELY TURN OFF POWER, REMOVE LAMP FROM LUMINAIRE AND CONTACT MANUFACTURER."

CAUTION - RISK OF FIRE - DO NOT INSTALL THIS DEVICE IN A PRE-HEATED LUMINAIRE.

CAUTION - BALLAST OPERATION NOT COMPATIBLE WITH CONTROLS.